

パネルアプライアンス &amp; モニタ &gt; マウントキット &amp; スタンド

## FPK-02

A set of Panel Mounting Kit is composed of a clamp and screw

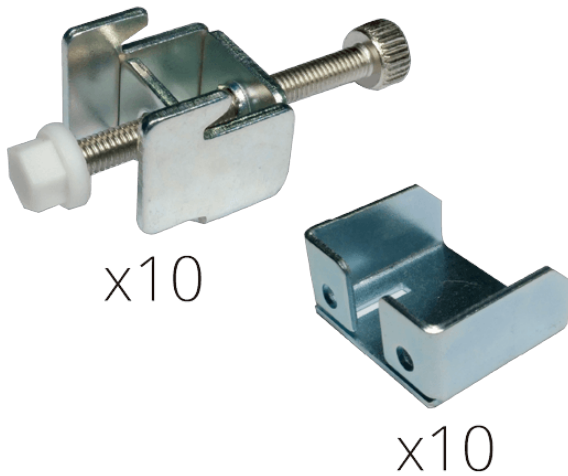

## Features

Panel Mounting Kit

## Specifications

Dimensions	
Dimensions	222 x 432 x 252 mm
Material	
Material	SPCC
Weight	
Weight	3.12 Kg
Key Features	
Key Features	12 mounting kits for DM-F24A

## Ordering Information

FPK-02-R10	DM-F22A panel mount kit, silver color, R10
------------	--